







SCREW: NONE	MATERIAL: COPPER	REV: D	ECM INDUSTRIES	
END ITEM: SEE CHART	PLATING: VIRITUM PLATED	DRAWN BY: MAH	SCALE: 1 : 1	ILSCO, KINGSBERGEN
INFORMATION SHEET: FORM 204	MARKING: SEE CHART	DATE: 6/25/2014	SIZE: B	800-776-9775 www.ilSCO.com

DWG NO: **M3058**
 SHEET: 1 OF 1

END ITEM	"A"	TERMINAL	MARKING
SBJ-14-6	6.00	R2465	ILSCO,  , SBJ-14, 
SBJ-14-712	7.50	R2465	
SBJ-14-9	9.00	R2465	
SBJ-14-1012	10.50	R2465	
SBJ-14-12	12.00	R2465	
SBJ-14-15	15.00	R2465	
SBJ-14-21	21.00	R2465	
SBJ-14-24	24.00	R2465	
SBJ-14-28	28.00	R2465	
SBJ-14-32	32.00	R2465	
SBJ-14-40	40.00	R2465	
SBJ-14-44	44.00	R2465	
SBJ-14-48	48.00	R2465	
SBJ-14-54	54.00	R2465	
SBJ-14-60	60.00	R2465	
SBJ-14-66	66.00	R2465	
SBJ-14-72	72.00	R2465	
SBJ-516-712	7.50	R2324	ILSCO,  , SBJ-516, 
SBJ-516-9	9.00	R2324	
SBJ-516-15	15.00	R2324	
SBJ-516-18	18.00	R2324	
SBJ-516-21	21.00	R2324	
SBJ-516-28	28.00	R2324	
SBJ-516-32	32.00	R2324	
SBJ-516-36	36.00	R2324	
SBJ-516-40	40.00	R2324	
SBJ-516-44	44.00	R2324	
SBJ-516-48	48.00	R2324	
SBJ-516-54	54.00	R2324	
SBJ-516-60	60.00	R2324	
SBJ-516-66	66.00	R2324	
SBJ-516-72	72.00	R2324	
SBJ-38-712	7.5	R2325	ILSCO,  , SBJ-38, 
SBJ-38-9	9	R2325	
SBJ-38-1012	10.5	R2325	
SBJ-38-12	12	R2325	
SBJ-38-21	21	R2325	
SBJ-38-24	24	R2325	
SBJ-38-28	28	R2325	
SBJ-38-32	32	R2325	
SBJ-38-36	36	R2325	
SBJ-38-40	40	R2325	
SBJ-38-44	44	R2325	
SBJ-38-54	54	R2325	
SBJ-38-60	60	R2325	
SBJ-38-66	66	R2325	
SBJ-38-72	72	R2325	

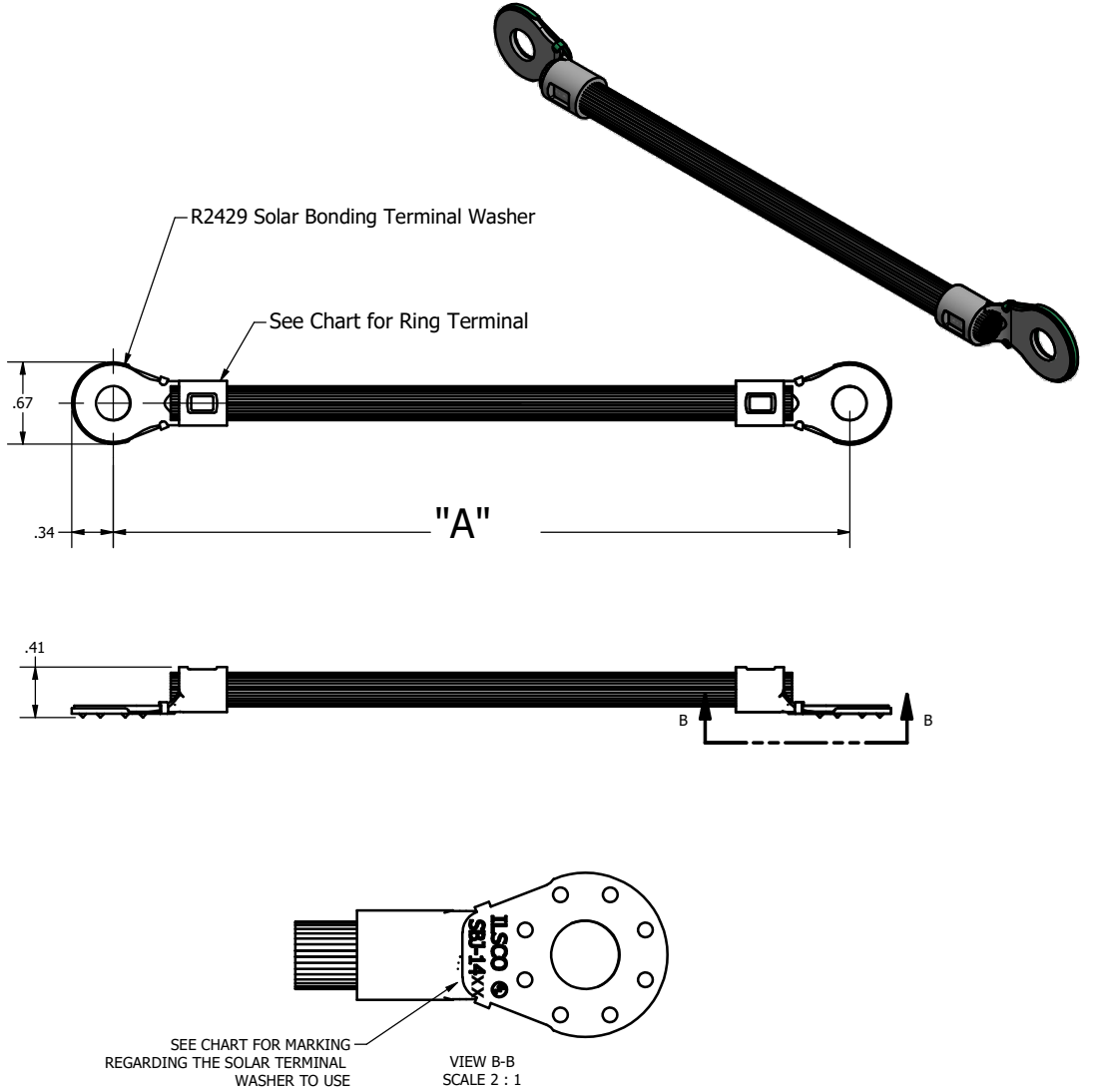

THIS PRINT AND INFORMATION THEREIN IS CONFIDENTIAL AND PROPRIETARY AND IS THE PROPERTY OF ECM INDUSTRIES. IT IS NOT TO BE COPIED OR REPRODUCED WITHOUT WRITTEN PERMISSION FROM ECM INDUSTRIES.